

# EICKWARM AIR VETERINARY WARMING SYSTEM

USER MANUAL



Item no. 648000  
Version A0, 06/2024

TELEPHONE +49 7461 96 580 0

[www.eickemeyer.com](http://www.eickemeyer.com)

veterinary technology for life  
**Eickemeyer**®

## **INTELLECTUAL PROPERTY RIGHTS**

Without the prior written permission of EICKEMEYER®, no individual or organization shall use, disclose or allow any other person to obtain any content, in whole or in part and by any means, of this manual, nor shall any individual or organization, including but not limited to, photocopy, reproduce, alter or translate into any other languages any content, in whole or in part, of this manual.

## **STATEMENT**

EICKEMEYER® reserves the right of final interpretation of this manual.

EICKEMEYER® reserves the right to modify the content of this manual without prior notice.

EICKEMEYER® reserves the right to change the product design, specification and model without notice.

EICKEMEYER® does not provide any form of warranty for this manual, including but not limited to any implied warranties of merchant ability and fitness of the product for a particular purpose.

EICKEMEYER® will be responsible for the safety, reliability and performance of the device only under the following conditions:

- The device is installed, operated, expanded, readjusted, improved and repaired by persons authorized by EICKEMEYER®;
- The device is used in accordance with the operating instructions;
- Relevant electrical equipment complies with applicable national standards.

EICKEMEYER® will assume no liability for the safety, reliability or operation condition of the device in any of the following situations:

- The service life of the product has expired and the product should be discarded as useless;
- The components are disassembled, assembled, stretched or re-commissioned without permission;
- The product is not properly used according to the User Manual.

## **SERVICE PROVIDER**

The local distributor.



## CONTENT

<b>1. Introduction</b>	<b>4</b>
1.1 Product Information	4
1.2 About the User Manual	4
1.3 Labels and Symbols	4
1.4 Conventions	6
1.5 Safety Information	6
1.6 Environmental Impact	8
<b>2. System Overview</b>	<b>8</b>
2.1 General Description	8
2.2 Intended Use	8
2.3 Structure and Components	8
<b>3. Operating Principle</b>	<b>9</b>
3.1 Product Features	9
3.2 Technical Parameters	9
3.3 Technical Specifications	10
3.4 Operating Principle	11
<b>4. Installation and Debugging</b>	<b>12</b>
4.1 Unpacking Inspection	12
4.2 Installation Requirements	12
4.2 Installation and Connection	13
4.4 Debugging	14
4.5 Startup / Shutdown	14
<b>5. Operation Instructions</b>	<b>15</b>
5.1 Operation Interface	15
5.2 Description of Interface Features	16
5.3 Preparation before Operation	16
5.4 Operation Methods	17
<b>6. Maintenance</b>	<b>18</b>
6.1 Maintenance and Repair	18
6.2 Maintenance Measures	18
6.3 Transport and Storage	19
6.4 Cleaning, Disinfecting and Sterilizing	19
6.5 Purchased Accessories List	20
6.6 Critic Component List	20
<b>7. Troubleshooting</b>	<b>20</b>
7.1 The Device Can Identify Common Faults and Alarm	20
7.2 No Display on the LCD Screen	21
7.3 Button is not Operating	21
7.4 Device Crashes	21
<b>8. Accessories and Consumables</b>	<b>21</b>
8.1 List of Accessories and Consumables	21
8.2 Replacement Cycle and Methods	21
8.3 Precautions for Use	22
<b>9. EMC Declaration</b>	<b>22</b>
<b>Annex A Technical Specifications</b>	<b>23</b>
<b>Annex B Guidance and Manufacturer's Declaration</b>	<b>24</b>
<b>Annex C Names and Contents of Toxic or Hazardous Substances or Elements</b>	<b>26</b>

# 1. INTRODUCTION

## 1.1 Product Information

---

Product Name: EickWarm Air Veterinary Warming System  
Production Date: See labels on main unit

## 1.2 About the User Manual

---

This manual describes the intended use, functions and properties, performance, installation and operation of the device in detail. Before using the device, please carefully read and get familiar with the contents of this manual, and keep it at a handy place for future reference.

This manual is prepared for healthcare professionals who have been adequately trained so that they can:



- get an understanding of the hardware and software of this device;
- set system parameters;
- perform routine operations;
- carry out system maintenance and troubleshooting.

Date of Manual Preparation/ Revision: May. 2024 Version: A0



















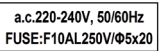

## 1.3 Labels and Symbols

---

The following labels and symbols are used in this manual to remind users of relevant hazards or information that requires special attention.

Symbols	Description
 Danger!	Indicates a situation of acute danger which, if not avoided, could lead to serious or fatal injuries.
 Warning!	Indicates a situation of potential danger which, if not avoided, could lead to serious injuries.
 Caution!	Indicates a situation of potential danger which, if not avoided, could lead to minor injuries.
Attention!	Indicates a situation of potential danger which, if not avoided, could lead to property loss.

Explanation of Labels and Silkscreen Symbols

Labels and Silkscreen Symbols	Description
	Protective grounding
	Alternating current
	Compliance with WEEE Standard
	Follow instructions for Use
	Keep dry
	Fragile, handle with care
	This way up
	Date of manufacture
	Serial number
	Symbol for Switch
	BF type application
	Power and Fuse information
	Sticking limit by number
	Air outlet symbol
	NO FREE HOSING
	Non Sterile
	Not made with Natural Rubber Latex
	Do not use if package is damaged
	Do not re-use
	Batch code
	Avoid sun beam
	Use-by date

### 1.4 Conventions

All illustrations provided in this manual are only used as examples, which shall not be used for any other purposes. The graphs, settings or data in the illustrations may be inconsistent with those of the actual product; in such case, the latter shall prevail.

### 1.5 Safety Information

Prior to use of this device, users must read the User Manual carefully. This manual informs the user of the operation steps that require attention, the operations that may result in abnormalities, and the hazards that may cause device damage or personal injury. Manufacturer will assume no liability for the safety, reliability and performance of the device in case of any abnormality, device damage or personal injury caused by any operations that must be avoided as specified herein. Nor will manufacturer provide free repair service for such failures!

#### 1.5.1 Contraindications

Do not apply heat to lower extremities during aortic cross-clamping. Thermal injury may occur if heat is applied to ischemic limbs.

#### 1.5.2 Safety Precautions

- Before using this device, be sure to read this user manual carefully!
- Please follow the instructions to use this product!
- Please use under the guidance of a doctor!
- Before using the device, please confirm that the user does not have the contraindications specified in this user manual!
- Before using the device, please confirm whether there is any obvious mechanical damage on the surface of the device.
- Do not leave patients with poor perfusion unmonitored during prolonged warming therapy sessions. Thermal injury may result.
- Do not use the air hose alone to heat the patient, otherwise it may cause thermal damage.
- The part covered by the product may affect the treatment effect.
- If the over-temperature indicator lights up and the alarm is heard, the treatment should not be continued, otherwise it may cause thermal damage, at this time, the device should be turned off and the relevant technical service personnel should be contacted.
- When the patient's body surface uses a good thermal conductivity material, such as water, gel, etc., not working or working with "normal temperature" mode may cause the patient's body temperature to decrease.
- This product should not be in direct contact with patients and users during use.
- When heating the patient, do not let the patient lie on the air hose or let the air hose directly contact the patient's skin, which may cause thermal damage.
- The device is not suitable for use in flammable anesthetics mixed with air, oxygen or nitrous oxide.
- According to the routine, every 10 to 20 minutes, the hospital should monitor the body temperature and skin reaction of patients who cannot respond, or have no sensation according to the practice. Regularly monitor the patient's vital signs. When the treatment goal is reached or the vital signs become unstable, adjust Gas temperature or termination of treatment. The doctor should be notified immediately if the vital signs are unstable.
- Authorized personnel must be supervising during the treatment of newborn animals and other vulnerable patients.
- Do not place the main unit on a soft, uneven surface, or on a wet surface, otherwise it will hinder air intake, cause the main unit to overheat, and affect the performance of the main unit.
- The maintenance technicians not designated by the manufacturer shall not disassemble the mainframe.
- Before using the device, make sure that the main unit, air hose, and the optional blanket are in good condition and the power plug is well fixed!
- It is forbidden to spill liquid on the device!
- Avoid using MRI (Nuclear Magnetic Resonance Imaging), high-frequency surgical devices or similar equipment at the same time to prevent system failure or system breakdown due to electromagnetic interference.

- When the Veterinary Warming System is used in the intensive care unit or operating room, the alarm sound generated by this device may be mixed with the alarm sound generated by other medical device, causing medical staff to ignore the alarm sound emitted by the Veterinary Warming System. Burns and injuries may be occurred under this situation.
- To ground this Veterinary Warming System, only connect to receptacles marked "Hospital Only," "Hospital Grade", or a reliable grounded outlet.

### 1.5.3 Safety Requirements

#### Number of treatable patients

The maximum number of patients that can be treated by this device at a time is one.

#### About interference

Do not use mobile phones near the device. The high-intensity electromagnetic interference radiated from such kind of devices may cause strong interference to the normal operation of the device.

#### Protection against water ingress

In order to prevent electric shock and reduce device failures, the device should be protected against water ingress. In case of accidental water ingress, please stop using the device immediately, and call for a professional technician to repair it prior to reuse.

#### Accuracy

Not involved (Non-detection and non-measurement device).

#### Prompts

- Key pressing sound: When pressing the keys on the operation panel, the device will emit a "beep" sound;
- Fault alarm: when a fault occurs, the device will emit an alarm sound of "di-di-di";
- Over-temperature alarm: When over-temperature occurs, the device will emit an alarm sound of "DiDiDi-DiDi".

#### Shelf Life

The shelf life of the device is 5 years. Once the device reaches beyond its shelf life, it must be disposed of in accordance with relevant local laws and regulations. For further information, please contact the manufacturer or the distributor.

- Relevant wastes, residues, etc., and the device and accessories exceeding the shelf life may influence the treatment effects. Please dispose of them properly to avoid polluting the environment.
- The device or accessories can be sent to the distributor or manufacturer for disposal if necessary.
- Only cleaned and disinfected device or accessories can be sent to or returned to the distributor or manufacturer for disposal.



#### Warning!

- Risk factors: Contaminated device or accessories
- Risk evaluations: Improper disposal of contaminated device or accessories may cause animal infection and environment pollution.
- Control measures: First clean and disinfect the device or accessories, and then dispose it.

## 1.6 Environmental Impact

Relevant wastes, residues, etc., and device and accessories may affect the treatment effects when exceeding the service life. Random disposal will pollute the environment, please handle them properly.

Local laws and regulations must be observed when packaging materials and products are discarded. Users shall properly dispose of such materials and products according to the requirements of local laws and regulations, and support shall be provided whenever possible for their classification and recycling work.

## 2. SYSTEM OVERVIEW

### 2.1 General Description

The Veterinary Warming System heats the air and fills into the blanket (seperately available) to keep the blanket at a suitable temperature. After the blanket is covered on the patient's body, the blanket has a larger contact area with the patient's skin, reducing the heat dissipation area on the body's surface and blocking the direct contact between the skin and the cold environment. The contact reduces the heat loss of the body, to prevent the temperature drop during the operation.

The Veterinary Warming System should only be used by trained medical professionals.

### 2.2 Intended Use

#### 2.2.1 Product Functions

The Veterinary Warming System has the function of in vitro physical heating of the animal body to achieve the purpose of auxiliary adjustment of the animal body temperature.

#### 2.2.2 Indications

The Veterinary Warming System is intended to prevent and treat hypothermia. In addition, the Veterinary Warming System can be used to provide patient thermal comfort when conditions exist that cause patients to become too warm or too cold. The Veterinary Warming System can be used with adult and pediatric patients.

### 2.3 Structure and Components

The product is composed of a main unit, air hose, a power cord and software.

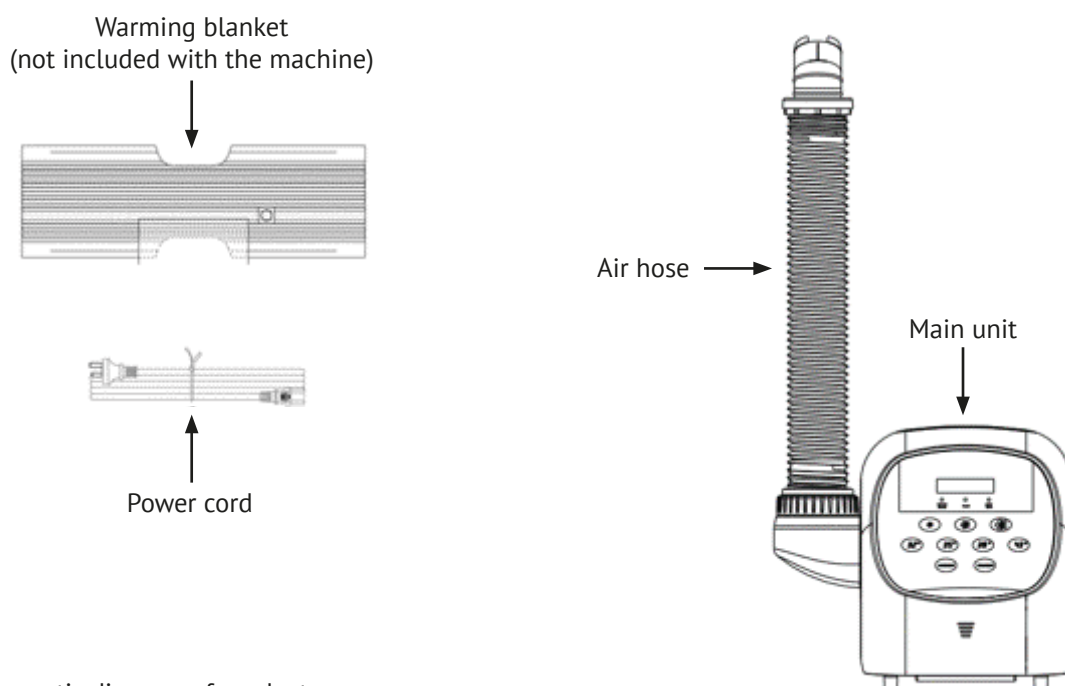

Figure 2.1 Schematic diagram of product appearance



## 2.3.1 Main Unit

The main unit system is mainly composed of a display board, a control board, a heating resistance wire, a blower, and an air hose. The display board is connected to the main control board through a cable, and the resistance wire and the blower are connected to the main control board through wires.

## 2.3.2 Accessories

User manual, operation guide and filter cotton.

# 3. OPERATING PRINCIPLE

## 3.1 Product Features

---

The device adopts mechanical buttons and OLED display design. The doctor can set different temperature, air volume and room temperature modes according to the treatment needs.

This system has the following characteristics:

- With 4 levels of temperature.
- With room temperature level mode.
- With 3 air volume levels.
- Support temperature and time display function.
- With alarm function.
- The device provides an independent circuit. When the temperature reaches the preset  $56 \pm 3$  °C, the independent switch turns off the heater and issues an alarm at the same time. The standby high temperature detection is located at the air hose inlet.

## 3.2 Technical Parameters

---

### 3.2.1 Temperature

32 °C :  $32 \pm 1.5$  °C;

35 °C :  $35 \pm 1.5$  °C;

38 °C :  $38 \pm 1.5$  °C;

43 °C :  $43 \pm 1.5$  °C;

Room temperature gear.

### 3.2.2 Air Volume

High air volume: not less than 30 CFM;

Stroke volume: not less than 28 CFM;

Low air volume: not less than 25 CFM.

### 3.2.3 Heating Time

Time to reach target temperature:

- 2-5 minutes (dependent on blanket model)
- Time required for the contact surface temperature to heat up from  $23 \pm 2$  °C to 37 °C

### 3.2.4 Noise

During normal operation, the noise level is  $\leq 55$  dB (A).

### 3.2.5 Functional Characteristics

- With room temperature mode;
- With temperature indication within the limit;
- With over temperature alarm function;
- With fault alarm function;
- With maintenance alarm function;

## 3.3 Technical Specifications

### 3.3.1 Safety Specification

- Classification by the rating of protection against electric shock: Class I
- Classification by the degree of protection against electric shock: Application unit of Type BF mode
- Classification by the ingress protection rating: Common equipment
- Classification by the safety level when used with inflammable anesthetic gas mixed with air, oxygen or nitrous oxide: N/A
- Classification by the operational mode: Continuous operation
- Classification by the installation and use ways: Portable mobile devices
- Classification by whether the device has a signal output or input section: No signal output or acquaintance part.
- Classification by the way in which the device is installed and used: Non-permanently installed device

### 3.3.2 Environmental Specification

	Ambient Temperature	Relative Humidity	Atmospheric Pressure
Operation Environment	5 °C ~ 40 °C	≤ 80 %	75 kPa ~ 106 kPa
Transport Environment	-20 °C ~ +55 °C	≤ 93 %	75 kPa ~ 106 kPa
Storage Environment	-20 °C ~ +55 °C	≤ 93 %	75 kPa ~ 106 kPa

### 3.3.3 Power Specification

Rated voltage	a.c. 220 – 240 V
Rated frequency	50 / 60 Hz
Input power	2000 VA
Fuse	F10AL250V, 5 × 20

### 3.3.4 Hardware Specification

Main Unit Display	
Model	OLED screen
Dimensions (Specification)	2.8 inch

Connectors	
Power connector	Three-core power socket with protective ground wire

### 3.3.5 Physical Specification

Net Weight / kg	Overall Dimension (L × W × H)
7.7 kg	490 × 360 × 550 (mm)

### 3.4 Operating Principle

The Veterinary Warming System inside the main unit generates the required heat to heat the air. At the same time, the blower draws the air heated to a certain temperature and outputs it to the blanket (not included with the machine) through the air hose. The surface of the blanket is provided with micropores, and the heated air can be distributed around the patient through the micropores to provide a warm environment for the patient. The built-in micro control unit can control the output temperature and air volume to meet the needs of different occasions.

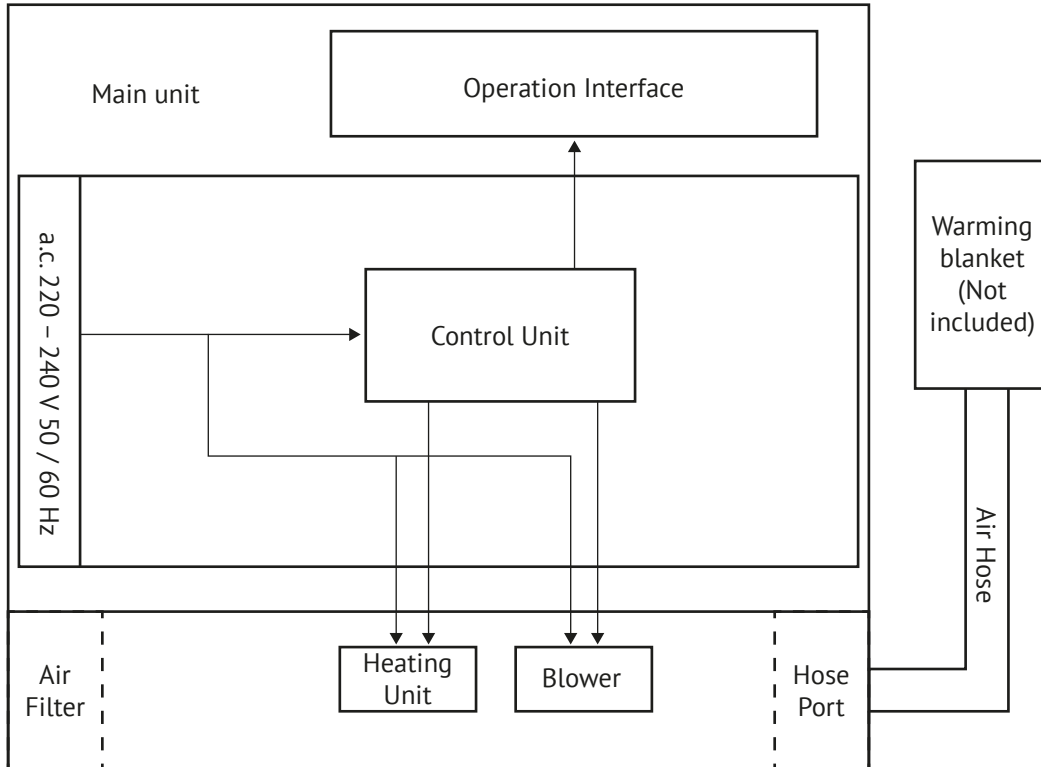

Figure 3.1 Schematic diagram

## 4. INSTALLATION AND DEBUGGING



### Warning!

- The operator must use the specified fuse.
- Make sure the input voltage meets the device requirement.
- All analog and digital devices connected with this device must have passed any required certifications in accordance with applicable international standards (e.g., IEC 60950-1 Information technology equipment-Safety and IEC 60601-1 Medical electrical equipment-Safety), and all devices should be connected according to the requirements as specified in the effective versions of IEC 60601-1-1 and IEC 60601-1-12. Personnel responsible for connecting auxiliary devices to the signal input and output ports are liable for the compliance of the system with IEC 60601-1. If you have any question, please feel free to contact us.
- When a combination having specific function is formed by connecting this device with other electrical devices, if it is impossible to simply determine whether this combination poses any hazards (e.g., electric shock hazard caused by leaked current crowding) from the specifications of each device, please contact manufacturer or any hospital expert in this area to ensure the required safety of all devices in this combination will not be impaired.
- In order to avoid damage to the device during unpacking or installation by persons not authorized or trained by manufacturer, please do not unpack or install the device before the arrival of manufacturer's authorized personnel.



### Caution!

- In order to avoid damage to the device during unpacking or installation by persons not authorized or trained by manufacturer, please do not unpack or install the device before the arrival of manufacturer's authorized personnel.

### 4.1 Unpacking Inspection

Before unpacking, please check the packing box carefully. If you find any damage, please contact the dealer or after-sales service immediately.

#### 4.1.1 Packing List

See the packing list in the package of the whole machine for details.

### 4.2 Installation Requirements

#### 4.2.1 Space Requirements

In order to allow the air to circulate smoothly to achieve good heat dissipation, at least 2 inches (5 cm) of clearance should be left around the device.

When the device is transferred from one environment to another, the difference in temperature or humidity may cause condensation in the device. At this time, you must wait for the condensation to disappear before using the device.

#### 4.2.2 Power Supply Requirements

Input Voltage	Frequency	Input Power	Fuse
a.c. 220 - 240 V	50 / 60 Hz	2000 VA	F10AL250V, 5 × 20

## 4.2 Installation and Connection

This device should be installed by a qualified maintenance engineer; only authorized maintenance engineers can open the casing.

1. Unpack the whole device.
2. Take out the main unit, power cord, air hose, and power cord separately. The air hose and power cord are detachable parts.



Figure 4.1 Main unit and accessories

3. Connect the air hose. At the end of the air hose with a threaded interface, take out the wires in the air hose and insert the terminal into the socket inside the air outlet of the main unit. Then insert the air hose to the air outlet of the main unit (the connector is equipped with a foolproof device, which needs to be aligned before it can be inserted), and rotate the threaded interface clockwise to fix the air hose tightly.

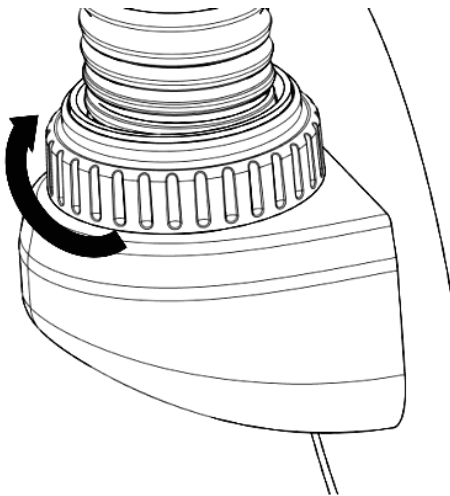

Figure 4.2 Connecting air hose

4. Insert the power cord plug into the power socket with a ground wire correctly and ground it securely, and insert the other end into the power input socket on the rear of the main unit; when removing, unplug the power socket first, then unplug the main unit side.



Figure 4.3 Connecting Power cord

- If you need to install the main unit on the optional trolley, just put the main unit on the trolley and tighten the four screws on the base.

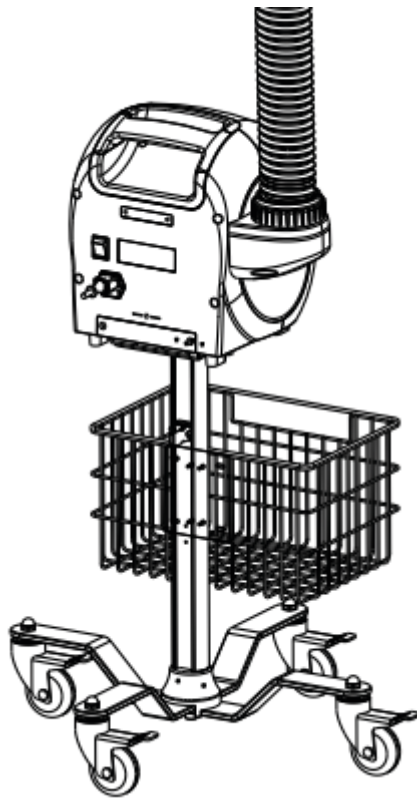

Figure 4.4 Install the Veterinary Warming System on the optional trolley

### 4.4 Debugging

---

Check whether the interface menus and buttons operate normally;  
After starting the device, check whether there is warm air blowing out of the air hose.

### 4.5 Startup / Shutdown

---

- Connect the power cord to the main unit, turn the switch on the back of the main unit to “I”, the power indicator lights up, and the main unit emits a boot prompt sound, the display shows the boot welcome screen, indicating that the main unit is powered on, and the device will automatically execute the following Power-on reset procedure:
- Display startup animation and perform all self-test functions.
- Prompt sound.
- Set the air volume to a high air volume and enter the standby mode.
- After the treatment is completed, set the switch on the back of the main unit to “O”, the display shuts down, indicating that it has been turned off.

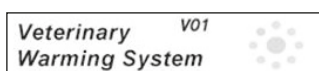

Figure 4.5 Display startup animation

## 5. OPERATION INSTRUCTIONS

### 5.1 Operation Interface

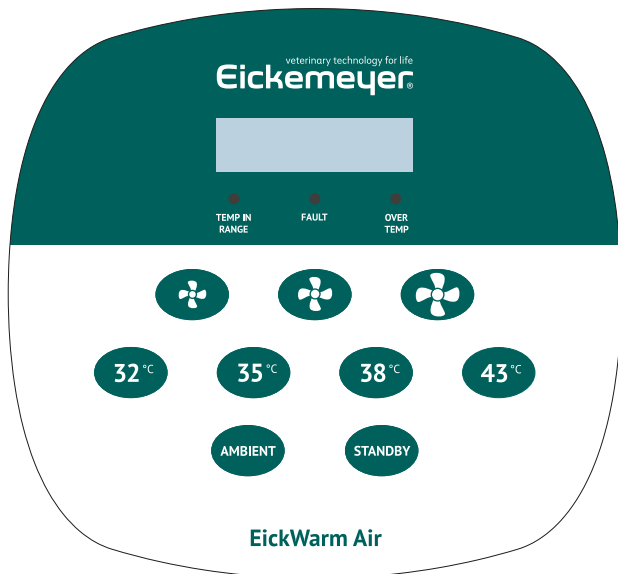











Figure 5.1 Operation interface

#### Display:



The display is a 2.8-inch OLED display, used to display all the data and prompts that need to be displayed on this device.

#### Button:

All buttons have indicator lights. When the button is selected, the corresponding indicator lights.

-  High air volume setting button;
-  Medium air volume setting button;
-  Low air volume setting button;
-  32 °C setting button;
-  35°C setting button;
-  38 °C setting button;
-  43 °C setting button;
-  Button for setting the room temperature mode;
-  Button for setting standby mode.

#### Indicator light

-  High air volume setting button;
-  Medium air volume setting button;
-  Low air volume setting button;

### 5.2 Description of Interface Features

---

#### Data Display

During normal operation, the display will show the temperature of the end of the air hose in the current mode, and the operating time in the current mode. When switching to other temperature ranges during operation, the operating time will be reset.



Figure 5.2 Data display

#### Temperature setting

- Press the 32 °C, 35 °C, 38 °C, 43 °C buttons to set the target temperature.
- Press the “room temperature” button to supply room temperature air.

#### Air volume setting

This device has three air volume gears, high air volume gear, medium air volume gear, low air volume gear, default is high air volume gear.

#### Standby

- Press the “Standby” button, the device enters standby mode.
- Temperature within limits indication
- When the temperature within limit indicator light is on, it indicates that the temperature is within the range of  $\pm 1.5$  °C of the selected setting.

#### Error indication

The device can recognize several common faults. When the system fails, the yellow indicator flashes and an alarm sounds will be heard. Please refer to the troubleshooting section for details.

#### Over temperature alarm

If the device senses that the temperature is out of range, the red over-temperature alarm light will flash and the screen will display “over-temperature” At the same time, the alarm will sound and the device will stop heating. Please refer to the troubleshooting section for details.

#### Maintenance tips

When the total operation time of the equipment reaches 2000 hours, it will enter the maintenance state. When the device is under maintenance, the screen will display “E06 Please replace the air filter” in the standby state.

### 5.3 Preparation before Operation

---

- Open the package first, and check the items according to the packing list. The operator needs to confirm whether the appearance is intact, for example, if it is damaged, please contact the supplier or manufacturer.
- Before starting the device, according to the actual situation, first place the device on a flat surface table or hang it on the trolley.
- Ensure that the bottom space of the device is not blocked.
- Lay the separately available blanket flat, then insert one end of the air hose into the blanket joint, twist the end of the air hose to ensure that it is tightly inserted.





**Warning!**

- Do not put the unpunched side of the blanket on the patient, otherwise it may cause thermal damage, and always face the punched side toward the patient when performing treatment.
- Turn on the power, press the power switch on the back of the device, and the user should operate the device directly in front of the operation panel of the device after turning on.

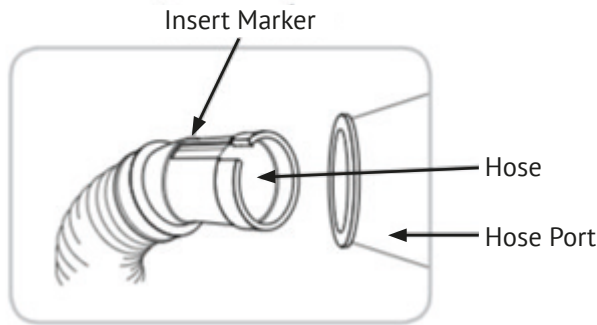

Figure 5.3 Schematic diagram of connecting the separately available warming blanket

## 5.4 Operation Methods

### 5.4.1 System Startup

Please connect the power cord before starting up. Press the power switch on the rear side of the main unit, the power indicator lights up, and the startup screen is displayed. After the device is turned on, enter the main interface. At this time, the device is in standby mode and the system pre-selects the high air volume setting by default. Before selecting the desired temperature range, other air volume ranges can be selected.

### 5.4.2 Start Treatment

Press the corresponding temperature setting button (32 °C, 35 °C, 38 °C, 43 °C or room temperature) to set the temperature. At this time, the device will start the treatment. During the treatment, the temperature and air volume can be switched at any time according to the actual needs.

### 5.4.3 Pause Treatment

Press the “Standby” button to pause the treatment, and press the buttons for different temperature and air volume again to restart the treatment.

### 5.4.4 Conclude Treatment

Press the “Standby” button to end the treatment and remove the blanket.

### 5.4.5 System Shutdown

Turn off the power and unplug the cable of the main unit.

## 5.5 Parameters Setting

### Air volume setting

After the device is turned on, the air volume defaults to the high-end position, and its indicator light will illuminate. The user can select the mid-range or low-range air volume before selecting the target temperature.



**Note!**

If you need to change the air volume setting, the user can press the corresponding air volume setting button at any time to switch between the high, medium and low air volume gears. However, these buttons will not set the device to standby.

### Temperature setting

Press the corresponding temperature button (32 °C, 35 °C, 38 °C, 43 °C or room temperature) to select the set temperature. When the device reaches the set temperature, the temperature within limit indicator will light up, and there will be no indication under the room temperature setting.

### Standby

Press the “Standby” button, the device will return to the standby mode, at this time the air volume range is reset to the high-end position.

### View device running time

In the standby state, long press the “Standby” button, you can view the total running time of the device, the display format is XXX (hours):XX (minutes):XX (seconds), as shown in Figure 5.4, after releasing the button the device will return to the standby interface.

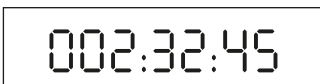

Figure 5.4 View device running time

## 6. MAINTENANCE



### Warning!

- Please use the device in clean environment;
- Do not use the device in flammable, high-temperature or humid environment;
- To avoid electric shock, the power cord must be plugged into a three-core power socket with a protective ground wire. Do not use a bad socket and equip the device with a stabilized voltage supply if possible;
- During treatment, the device should avoid vibration and be kept away from materials that are corrosive, flammable or explosive.

### 6.1 Maintenance and Repair

---

Proper maintenance is required to ensure that the device can give its performance for a long time. Manufacturer will provide long time maintenance services for users in addition to the one-year free warranty service. Please follow the maintenance measures proposed by manufacturer to maintain the device.

### 6.2 Maintenance Measures

---

#### Precautions for use

- Before using the product, follow the doctor’s advice to confirm whether there is a risk of contraindications.
- Prohibited to use in the environment with flammable gas.
- Before each use of this device, please perform preventive checks to confirm whether the power cord is connected and whether the casing is intact; if the device is not used for a long time, preventive inspections must be carried out regularly, and the inspection cycle should be one month.
- Avoid electric shock, don’t use bad sockets, please provide regulated power supply if possible.
- The use environment must be kept clean, avoid using in high temperature or humid environment.
- Avoid vibration during use, keep away from corrosive products, flammable and explosive products.

**Maintenance measures**

- Pay attention to the local power grid voltage fluctuations. If it exceeds the allowable range, it is recommended to add voltage stabilizing equipment.
- Various adjustable components such as potentiometers in the device are not allowed to be adjusted without permission, so as to avoid undesirable failure that affects normal use.
- Please check and maintain the metal bracket regularly to prevent aging and breakage three months is appropriate.
- The recommended replacement cycle of the air filter: after 24 months or 2000 hours of use.

**6.3 Transport and Storage**

**Transportation**

- It can be transported by car, train, or plane, and operates according to the order contract. During transportation, it should not be beaten or collided with force. Rain and snow splash and mechanical collision should be avoided.
- Ambient temperature: -20 °C ~ +55 °C;
- Relative humidity: ≤ 93 %;
- Atmospheric pressure: 75 kPa ~ 106 kPa.

**Storage**

- Storage place: If the device is not used for a long time, it should be covered with a dustproof cloth after being wiped clean, and stored in a cool, dry and dust-free place to avoid high temperature exposure;
- Ambient temperature: -20 °C ~ +55 °C;
- Relative humidity: ≤93 %;
- Atmospheric pressure: 75 kPa ~ 106 kPa.
- No corrosive gas and well-ventilated room.

**6.4 Cleaning, Disinfecting and Sterilizing**

Serial Number	Parts	Preparation before Cleaning	Operation Steps	Precautions	Frequency
1	Main unit outer shell	Turn off the device and unplug the power cord	<ol style="list-style-type: none"> <li>1. Disconnect the warming blanket before cleaning.</li> <li>2. It should be cleaned according to hospital cleaning or equipment specifications. After each use, wipe the main unit, the outside of the air duct, and any surfaces that may be touched. Use a soft damp cloth and hospital-approved mild detergent, disposable sterilizing paper towels, disinfecting wipes, or sterilizing spray.</li> <li>3. Air dry or dry with a separate clean soft cloth.</li> </ol>	It is forbidden to wipe with corrosive liquids; Do not dip in excess cleaning solution; The use of flushing is prohibited.	weekly
2	Air hose	Turn off the device and unplug the power cord	<ol style="list-style-type: none"> <li>1. Disconnect the warming blanket before cleaning.</li> <li>2. It should be cleaned according to hospital cleaning or equipment specifications. After each use, wipe the main unit, the outside of the air duct, and any surfaces that may be touched. Use a soft damp cloth and hospital-approved mild detergent, disposable sterilizing paper towels, disinfecting wipes, or sterilizing spray.</li> <li>3. Air dry or dry with a separate clean soft cloth.</li> </ol>	It is forbidden to wipe with corrosive liquids; Do not dip in excess cleaning solution; The use of flushing is prohibited.	weekly

## 6.5 Purchased Accessories List

Not involved.

## 6.6 Critic Component List

Circuit diagrams, component list, legends, calibration details, or other necessary information for qualified technicians to assist users in repairing parts of the device are available upon request.

# 7. TROUBLESHOOTING

## 7.1 The Device Can Identify Common Faults and Alarm

- The device is equipped with a visual and auditory security alarm system, which can identify several common faults and alarm.
- When the device is turned on and the device performs a self-test, the alarm sounds and all the indicators light up at the same time. You must check whether the alarm sound and the indicator are operating normally. During the check, you need to confirm the indicator and alarm at a position about 1 m in front of the device, the sound is clearly legible.
- When an alarm occurs, the alarm system will respond immediately, the fault indicator will flash, the fault information will be displayed on the screen, and the buzzer will emit an alarm sound. The fault information is shown in the following table.

Fault Code	Content	Alarm Sound	Alarm Priority	Suggested Measure
E01	Sensor-1 Abnormal	Di-Di-Di > 65 dB	Intermediate priority	Stop all treatment immediately, shut down, contact a professional
E02	Sensor-2 Abnormal	Di-Di-Di > 65 dB	Intermediate priority	Stop all treatment immediately, shut down, contact a professional
E03	Blower Unit Abnormal	Di-Di-Di > 65 dB	Intermediate priority	Restart the device
E04	Heating Unit Abnormal	Di-Di-Di > 65 dB	Intermediate priority	Restart the device
E05	Air Outlet OVER-TEMP	DiDiDi-DiDi > 65 dB	Higher priority	Stop all treatment immediately, shut down, contact a professional
E06	Please Replace The Filter	Di-Di-Di > 65 dB	Intermediate priority	Stop all treatment immediately, shut down, replace air filter
E07	Not Reaching The TEMP	Di-Di-Di > 65 dB	Intermediate priority	Shut down, check the air hose
E08	Air Hose End OVER-TEMP	DiDiDi-DiDi > 65 dB	Higher priority	Stop all treatment immediately, shut down, contact a professional

### Alarm setting reset:

When the power failure time is less than 30 s, the alarm setting will be automatically reset before the power is automatically reset. After the reset is completed, the Veterinary Warming System restarts and completes the self-check.

### The alarm sound is paused:

When the Veterinary Warming System detects an abnormality and generates an alarm signal, when the medical staffs perceive the alarm signal and are dealing with the abnormal event, they can press any button on the operation panel to pause the sound alarm signal. The sound pause interval is 10 minutes.



### Caution!

When an alarm occurs, the alarm sound and the indicator light will respond at the same time. Before the alarm condition is removed, press any key to pause the alarm sound, but the light of the indicator light will not be suspended. At the same time, the suspended alarm sound will be again after 10 min sounded.

## 7.2 No Display on the LCD Screen

- Check if the power plug is correctly inserted;
- Check if the fuse is intact;
- Check if the mains switch is on;

## 7.3 Button is not Operating

- Disconnect and reconnect the power of the whole device, and turn on the power switch.
- If the device still cannot respond to the operation, please contact with your local distributor.
- After the above inspection, if the fault is still not eliminated, please contact the designated after-sales service unit for repair.

## 7.4 Device Crashes

- Check whether the mains voltage is stable and check whether the operation is performed strictly in accordance with this manual;
- Disconnect the power of the whole device, and restart it later.

# 8. ACCESSORIES AND CONSUMABLES

## 8.1 List of Accessories and Consumables

For details, see the list of accessories included in the main unit package.

## 8.2 Replacement Cycle and Methods

No.	Item Name	Replacement Cycle	Replacement Methods
1	Warming blanket	Replace when damaged	Replace a new blanket, and dispose the old one as medical waste
2	Fuse	Replace when damaged	<ol style="list-style-type: none"> <li>1. Turn off the power of the device first, and unplug the power cord from the socket of the main unit to ensure that the device is in a non-powered state;</li> <li>2. As shown in Figure 8.1, use a flat-blade screwdriver to pry out the fuse chute and take out the damaged fuse;</li> <li>3. Insert a new fuse, push the fuse chute back to its original position, and confirm that it is firmly tightened;</li> <li>4. Reinsert the power cord and power on, if the device is turned on normally, the fuse is successfully replaced;</li> <li>5. If you cannot replace it by yourself, please contact the maintenance personnel.</li> </ol>
3	Air filter	After 24 months or 2000 hours of operation	<ol style="list-style-type: none"> <li>1. Turn off the power of the device first, and unplug the power cord from the socket of the main unit to ensure that the device is in a non-powered state;</li> <li>2. As shown in Figure 8.2, use a Phillips screwdriver to remove the screws that fix the filter, push out the fixing plate that fixes the air filter, and then take out the internal air filter;</li> <li>3. Install a new air filter, replace the fixing plate that fixes the filter, reinstall the screws, and confirm that it is tightly tightened;</li> <li>4. If you cannot replace it by yourself, please contact the maintenance personnel.</li> </ol>

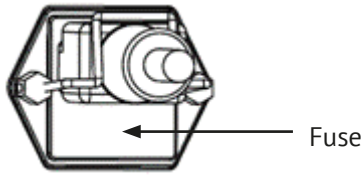

Figure 8.1 Schematic diagram of fuse replacement

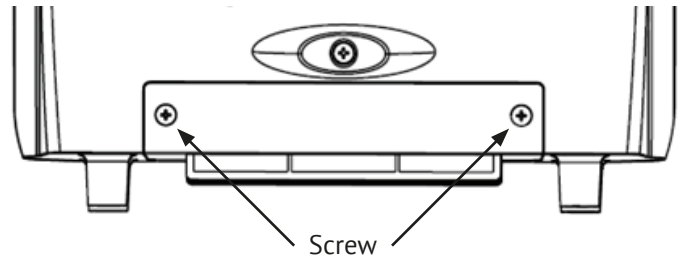

Figure 8.2 Schematic diagram of air filter

### 8.3 Precautions for Use

No.	Name	Precautions
1	Power cord	Do not disassemble and pull vigorously
2	Warming blanket	Do not contact with corrosive substances at will, or near fire sources, such as hot metals, stoves, cigarettes



If any accessories, parts or materials need to be replaced, please contact the authorized after-sales service provider of manufacturer. Do not use any accessories, parts or materials not matching the device which may result in unpredictable consequences.

## 9. EMC DECLARATION

### Electromagnetic Compatibility



- Veterinary Warming System complies with the relevant electromagnetic compatibility requirements of the EN 60601-1-2-2014 standard. It has no adverse effects on other electromagnetic equipment and cannot be affected by other exist electronic equipment. Once the device is used with other electronic equipment (such as measuring devices), the device efficacy should be checked before use.
- Veterinary Warming System complies with the relevant requirements of Class A.
- The user should install and use the device according to the electromagnetic compatibility information provided in the manual.
- Portable and mobile RF communication equipment may affect the performance of the Veterinary Warming System. When using the device, please avoid strong electromagnetic interference environment, such as place it near mobile phones, microwave ovens, and so on.
- Guidelines and manufacturer’s declaration are detailed described in Annex B.



### Warning!

- The device is not allowed to be positioned immediately next to or jointly with other devices. If the operation near or jointly with other devices is required, the device must be tested in that particular environment to ensure operation according to technical specification.
- The Class A devices are intended for industrial uses. Due to the conducted and radiated disturbances of the Veterinary Warming System, it may be potentially difficult to ensure the electromagnetic compatibility in other environments.
- The use of accessories or cables that are not authorized by the manufacturer can result in increased interference emissions or reduced resistance to interference emissions by the device.

## ANNEX A TECHNICAL SPECIFICATIONS

### A.1 Safety Specification

- Classification by the rating of protection against electric shock: Class I
- Classification by the degree of protection against electric shock: Application unit of Type BF mode
- Classification by the ingress protection rating: Common equipment
- Classification by the safety level when used with inflammable anesthetic gas mixed with air, oxygen or nitrous oxide: N/A
- Classification by the operational mode: Continuous operation
- Classification by the installation and use ways: Portable mobile devices
- Classification by whether the device has a signal output or input section: No signal output or acquaintance part.
- Classification by the way in which the device is installed and used: Non-permanently installed device

### A.2 Environmental Specification

	Ambient Temperature	Relative Humidity	Atmospheric Pressure
Operation Environment	5 °C – 40 °C	≤ 80 %	75 kPa – 106 kPa
Transport Environment	-20 °C – +55 °C	≤ 93 %	75 kPa – 106 kPa
Storage Environment	-20 °C – +55 °C	≤ 93 %	75 kPa – 106 kPa

### A.3 Power Specification

Rated voltage	a.c. 220 – 240V
Rated frequency	50/60 Hz
Input power	2000 VA
Fuse	F10AL250V, 5 × 20

### A.4 Hardware Specification

Main Unit Display	
Model	OLED screen
Dimensions (Specification)	2.8 inch

Connectors	
Power connector	Three-core power socket with protective ground wire
Serial port	Φ 57 mm

### A.5 Physical Specification

Net Weight / kg	Overall Dimension (L × W × H)
7.7 kg	490 × 360 × 550 (mm)

## ANNEX B GUIDANCE AND MANUFACTURER'S DECLARATION

Guidance and Manufacturer's Declaration – Electromagnetic Emissions		
The device is intended for use in the electromagnetic environment specified below, The customer or the user of the device should ensure that it is used in such an environment.		
Emissions Test	Compliance	Electromagnetic Environment-guidance
RF emissions CISPR 11	Group 1	The device uses RF energy only for its internal function. Therefore, its RF emissions are very low and are not likely to cause any interference in nearby electronic equipment.
RF emissions CISPR 11	Group A	The device is suitable for use in all establishments, including domestic establishment and those directly connected to the public low-voltage power supply network that supplies buildings used for domestic purposes.
Harmonic emissions IEC 61000-3-2	Group A	
Voltage fluctuations / flicker emissions IEC 61000-3-3	Complies	

Guidance and Manufacturer's Declaration – Electromagnetic Immunity			
The device is intended for use in the electromagnetic environment specified below. The customer or the user of the device should ensure that it is used in such an environment.			
Immunity Test	IEC 60601 Test Level	Compliance Level	Electromagnetic Environment-guidance
Electrostatic Discharge(ESD) IEC 61000-4-2	± 6 kV contact ± 8 kV air	± 6 kV contact ± 8 kV air	Floors should be wood, concrete or ceramic tile. If floors are covered with synthetic material, the relative humidity should be at least 30 %.
Electrical fast transient/burst IEC 61000-4-4	± 2 kV for power Supply lines ± 1 kV for input / output lines	± 2 kV for power Supply lines ± 1 kV for input / output lines	Mains power quality should be that of a typical commercial or a hospital environment.
Surge IEC 61000-4-5	± 1 kV differential mode ± 2 kV common mode	± 1 kV differential mode ± 2 kV common mode	Mains power quality should be that of a typical commercial or a hospital environment.
Voltage dips short Interruptions and voltage variations on power supply input lines IEC 61000-4-11	< 5 % $U_T$ (> 95 % dip in $U_T$ ) FOR 0,5 cycles  40 % $U_T$ (60 % dip in $U_T$ ) for 5 cycles  < 5% $U_T$ (> 95 %dip in $U_T$ ) for 5 sec	< 5 % $U_T$ (> 95 % dip in $U_T$ ) FOR 0,5 cycles  40 % $U_T$ (60 % dip in $U_T$ ) for 5 cycles  < 5 % $U_T$ (> 95 % dip in $U_T$ ) for 5 sec	Mains power quality should be that of a typical commercial or a hospital environment. If the user of the device requires continued operation during power mains interruptions, it is recommended that the device be powered from an uninterruptible power supply or a battery.
Power frequency (50 / 60 Hz) magnetic field IEC 61000-4-8	3 A/m	3 A/m	Power frequency magnetic fields should be at levels characteristic of a typical location in a typical commercial or hospital environment.
NOTE: $U_T$ is the a.c. mains voltage prior to application of the test level.			



Immunity Test	IEC 60601 Test Level	Compliance Level	Electromagnetic Environment-guidance
Conducted RF IEC 61000-4-6	3 Vms 150 kHz to 80 MHz	3 V	Portable and mobile RF communications equipment should be used no closer to any part of the device, including cables, than the recommended separation distance calculate from the equation applicable to frequency of the transmitter. Recommended separation distance $d = 1.2 \sqrt{P}$ $d = 1.2 \sqrt{P}$ 80M Hz to 800 MHz $d = 2.3 \sqrt{P}$ 800 MHz to 2.5 GHz where $P$ is the maximum output power rating of the transmitter in watts (W) according to the transmitter distance in metres (m). Field strengths from fixed RF transmitters, as determined by an electromagnetic site survey, <sup>A</sup> should be less than the compliance level in each frequency range. <sup>B</sup> Interference may occur in the vicinity of equipment marked with the following symbol 
Radiated RF IEC 61000-4-3	3 Vms 80 MHz to 2.5 GHz	3 V/m	

NOTE 1: At 80 MHz and 800 MHz, the higher frequency range applies.

NOTE 2: These guidelines may not apply in all situations. Electromagnetic propagation is affected by absorption and reflection from structures, objects and people.

<sup>A</sup> Field strengths from fixed transmitters, such as base stations for radio (cellular/cordless) telephones and land mobile radios, amateur radio, AM and FM radio broadcast and TV broadcast cannot be predicated theoretically survey should be considered. If the measured field strength in the location in which the device is used exceeds the applicable RF compliance level above, the Medical device should be observed to verify normal operation. If abnormal performance is observed, additional measures may be necessary, such as reorienting or relocating the device.

<sup>B</sup> Over the frequency range 150 kHz to 80 MHz, field strengths should be less than  $[V1]$  V/m.

### Recommended Separation Distances Between Portable and Mobile RF Communications Equipment and the Medical Device

The device is intended for use in an electromagnetic environment in which radiated RF disturbances are controlled. The customer or the user of the Medical device can help prevent electromagnetic interference by maintaining a minimum distance between portable and mobile RF communications equipment (transmitters) and the device as recommended below, according to the maximum output power of the communications equipment.

Rated maximum output power of transmitter W	Separation Distance According to Frequency of Transmitter m		
	150 kHz to 80 MHz $d = [ \frac{3.5}{\sqrt{f}} ] \sqrt{P}$	80 MHz to 800 MHz $d = [ \frac{3.5}{\sqrt{f}} ] \sqrt{P}$	800 MHz to 2.5 GHz $d = [ \frac{7}{\sqrt{f}} ] \sqrt{P}$
0.01	0.12	0.12	0.23
0.1	0.38	0.38	0.37
1	1.2	1.2	2.3
10	3.8	3.8	7.3
100	12	12	23

For transmitters rated at a maximum output power not listed above, the recommended separation distance  $d$  in meters (m) can estimated using the equation applicable to the frequency of the transmitter, where  $P$  is the maximum output power rating of the transmitter in watts (W) according to the transmitter manufacturer.

NOTE 1: AT 80 MHz, the separation distance for the higher frequency range applies.

NOTE 2: These guidelines may not apply in all situations. Electromagnetic propagation is affected by absorption and reflection from structures, objects and people.

## ANNEX C NAMES AND CONTENTS OF TOXIC OR HAZARDOUS SUBSTANCES OR ELEMENTS

Part		Toxic or Hazardous Substances or Elements					
		Pb	Hg	Cd	Cr (VI)	PBB	PBDE
Main unit	PCBA of control panel	○	○	○	○	○	○
	Display screen assembly	○	○	○	○	○	○
	Sheet metal parts	○	○	○	○	○	○
	Hardware	○	○	○	○	○	○
	Connecting cable	○	○	○	○	○	○
Accessories	Signs and labels	○	○	○	○	○	○
	Protective goggles	○	○	○	○	○	○
Package	Packaging materials	○	○	○	○	○	○

○: Indicates that the content of this toxic or hazardous substance in all homogeneous materials of the corresponding part is below the limit specified in ROHS 2011/65/EU.

X: Indicates that the content of this toxic or hazardous substance in at least one homogeneous material of the corresponding part is above the limit specified in ROHS 2011/65/EU.

(For items marked "X" in the table, further explanations on relevant technical reasons should be given according to the actual situation.)

Note: 70 % of the parts of this product are made of nontoxic and nonhazardous environment-friendly materials. Currently the parts containing toxic or hazardous substances or elements cannot be replaced by those containing no such substances or elements due to the limited level of global technological development in this respect.

P/N: 07-0000000-01142(A0)



GERMANY

EICKEMEYER KG  
Eltastraße 8  
78532 Tuttlingen  
T +49 7461 96 580 0  
F +49 7461 96 580 90  
info@eickemeyer.de  
www.eickemeyer.de

SWITZERLAND

EICKEMEYER AG  
Sandgrube 29  
9050 Appenzell  
T +41 71 788 23 13  
F +41 71 788 23 14  
info@eickemeyer.ch  
www.eickemeyer.ch

POLAND

EICKEMEYER Sp. z o.o.  
Al. Jana Pawła II 27  
00-867 Warszawa  
T +48 22 185 55 76  
F +48 22 185 59 40  
info@eickemeyer.pl  
www.eickemeyer.pl

ITALY

EICKEMEYER S.R.L.  
Via G. Verdi 8  
65015 Montesilvano (PE)  
T +39 085 935 4078  
F +39 085 935 9471  
info@eickemeyer.it  
www.eickemeyer.it

DENMARK

EICKEMEYER ApS  
Solbakken 26, Hammelev  
6500 Vojens  
T +45 7020 5019  
info@eickemeyer.dk  
www.eickemeyer.dk

NETHERLANDS

EICKEMEYER B.V.  
Doejenburg 203  
4021 HR Maurik  
T +31 345 58 9400  
info@eickemeyer.nl  
www.eickemeyer.nl

UNITED KINGDOM

EICKEMEYER Ltd.  
3 Windmill Business Village  
Brooklands Close  
Sunbury-on-Thames  
Surrey, TW16 7DY  
T +44 20 8891 2007  
info@eickemeyer.co.uk  
www.eickemeyer.co.uk

CANADA

EICKEMEYER Inc.  
617 Douro Street  
Suite 205  
Stratford, Ont. Canada  
N5A 0B5  
T +1 519 273 5558  
info@eickemeyervet.ca  
www.eickemeyercanada.ca